

B E N J A M I N

DESIGN BY
BENNY FRANDSEN

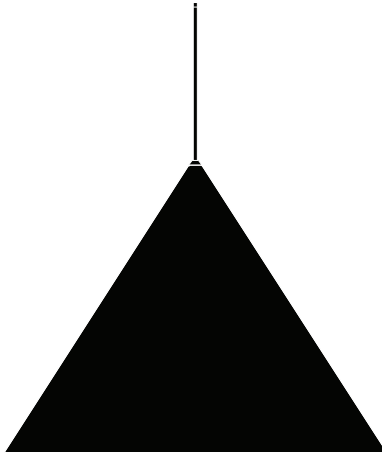

FRANDSEN

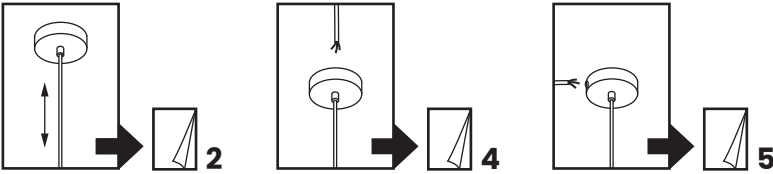

DK - SIKKERHEDSFORANSTALTNINGER

Den grønne og gule ledning må kun være forbundet til indgangen markeret med

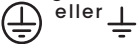

Hvis lampens udvendige ledning bliver beskadiget skal der, for at undgå en farlig situation, rettes henvendelse til producenten, service agenten eller anden lignende kvalificeret person for udskiftning af denne.

UK - SAFETY PRECAUTIONS

The core with green/yellow insulation must only be connected to a terminal marked with

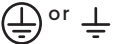

If the external flexible cable or cord of this luminaire is damaged, it shall be exclusively replaced by the manufacturer or his service agent or a similar qualified person in order to avoid a hazard.

F - PRÉCAUTIONS DE SÉCURITÉ

Le câble vert et jaune doit être connecté uniquement à une borne marquée par ou

Si le câble flexible externe ou le cordon de ce luminaire est endommagé, il doit être exclusivement remplacé par le fabricant, son agent de service ou une personne qualifiée similaire afin d'éviter tout danger.

E - MEDIDAS DE SEGURIDAD

El cable verde/amarillo solo debe conectarse a un terminal marcado con o

Si el cable externo o cordón de esta luminaria es dañado, deberá ser reemplazado exclusivamente por el fabricante, su agente comercial o persona cualificada similar para evitar cualquier peligro.

D - SICHERHEITSVORKEHRUNGEN

Die grün/gelb isolierte Ader darf nur an eine Klemme angeschlossen werden, die wie folgt gekennzeichnet ist oder

Wenn das äußere flexible Kabel oder die Schnur dieser Leuchte beschädigt ist, darf nur der Hersteller oder sein Kundendienst oder eine ähnlich qualifizierte Person das Kabel ersetzen, um eine Gefährdung zu vermeiden.

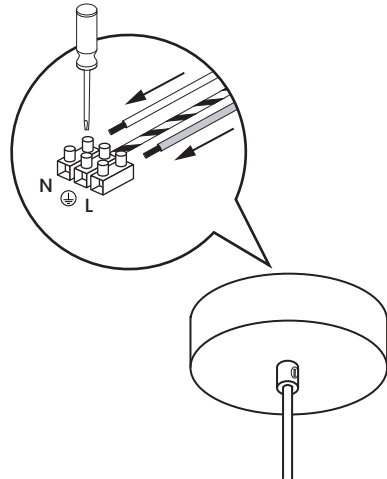
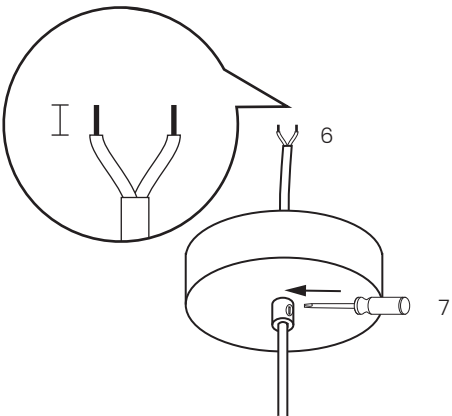
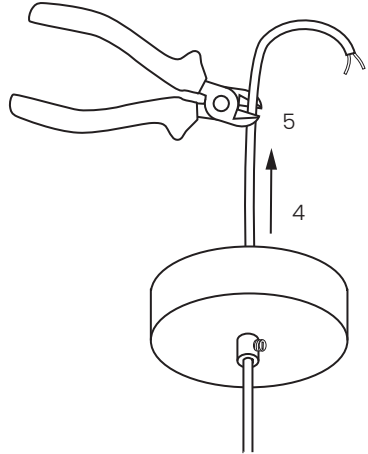
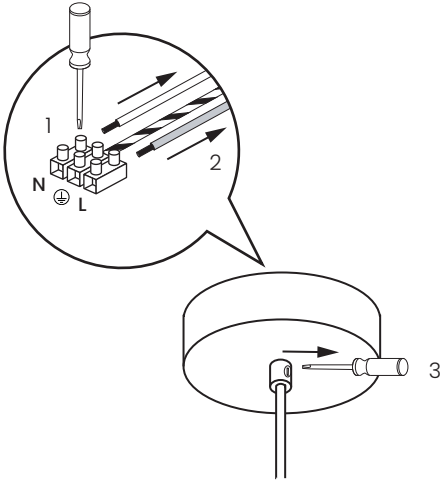
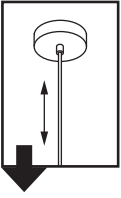

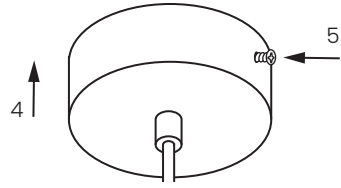
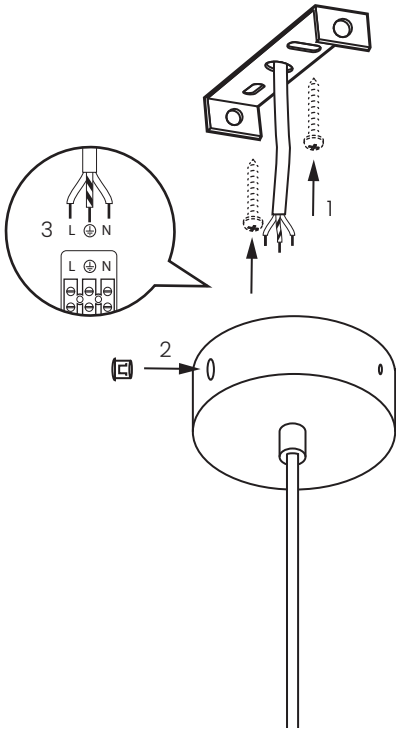
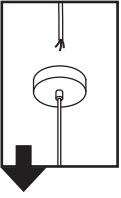

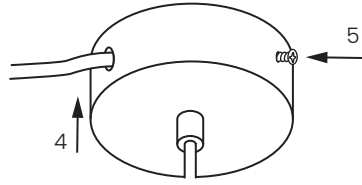
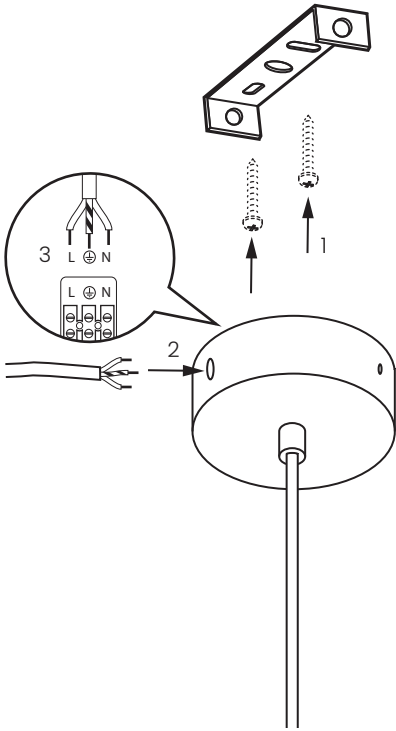
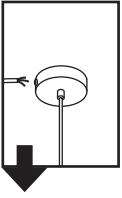

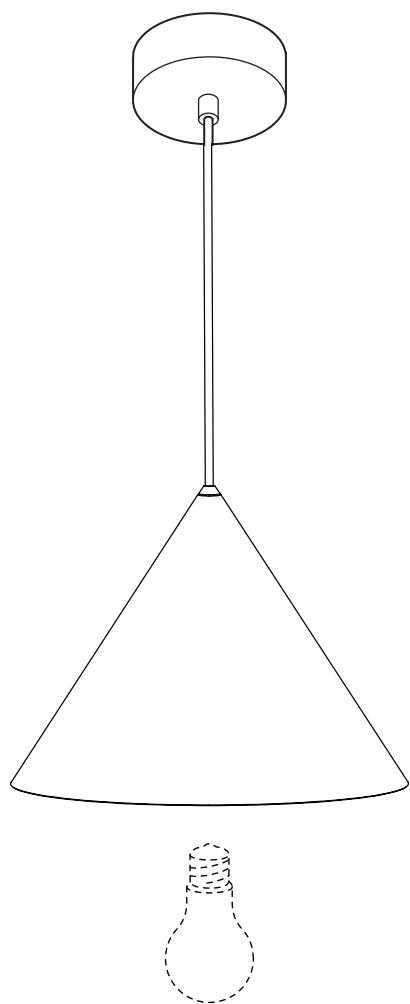

FRANDSEN